









## NS UNION DWCC 2550 MT



 Tirana - Albania  
 [info@newshipping.net](mailto:info@newshipping.net)  
 NewShippingSA

 +35542200166  
 <http://www.newshipping.net/>  
 [new.shipping](http://new.shipping)

### General

<b>Name:</b>	NS UNION	<b>Built:</b>	1986
<b>IMO No:</b>	8502133	<b>Call Sign:</b>	C5J134
<b>Flag:</b>	GAMBIA	<b>Port of Registry:</b>	BANJUL
<b>Class:</b>	Alfa Register of Shipping	<b>Type of Vesell:</b>	GENERAL CARGO
<b>DWT/DWCC:</b>	2700MT / 2550MT	<b>Summer Draft:</b>	4.16m
<b>GT/NT:</b>	1543MT / 860MT	<b>LOA:</b>	87.66m / beam 11.10m / depth 5.21m
<b>Owner/Manager:</b>	OUTCAST MARINE CORP./ OUTCAST MARINE CORP.	<b>P&amp;I CLUB:</b>	TURK P&I

### Hold/Hatches

<b>1 HATCH:</b>	62.80m x 8.50m
<b>2 HOLDS:</b>	31.20m x 9.20m x 5.58m 31.60m x 9.20m x 5.58m
<b>Grain/Bale:</b>	112 583 cft / 111 806 cft



# Pocket Plan

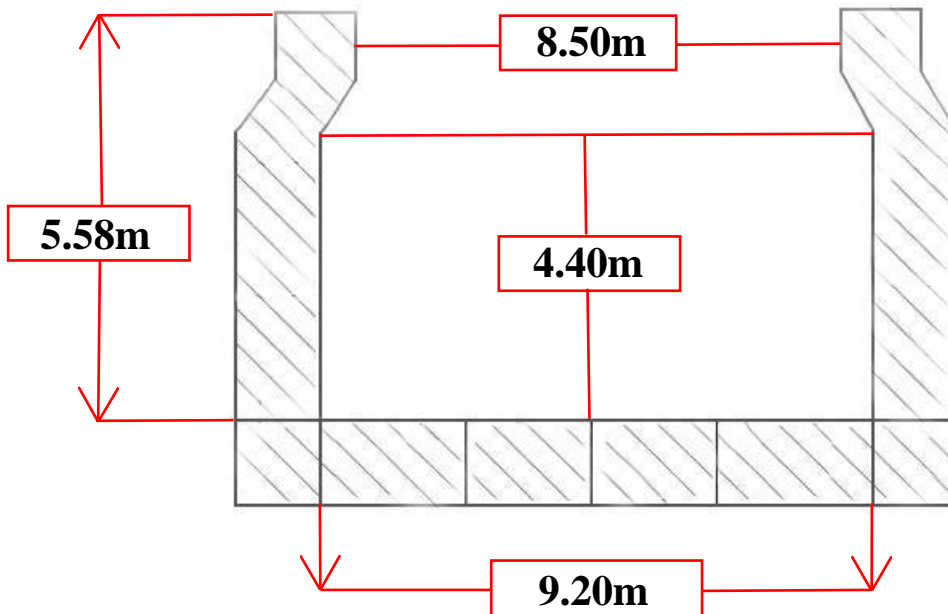
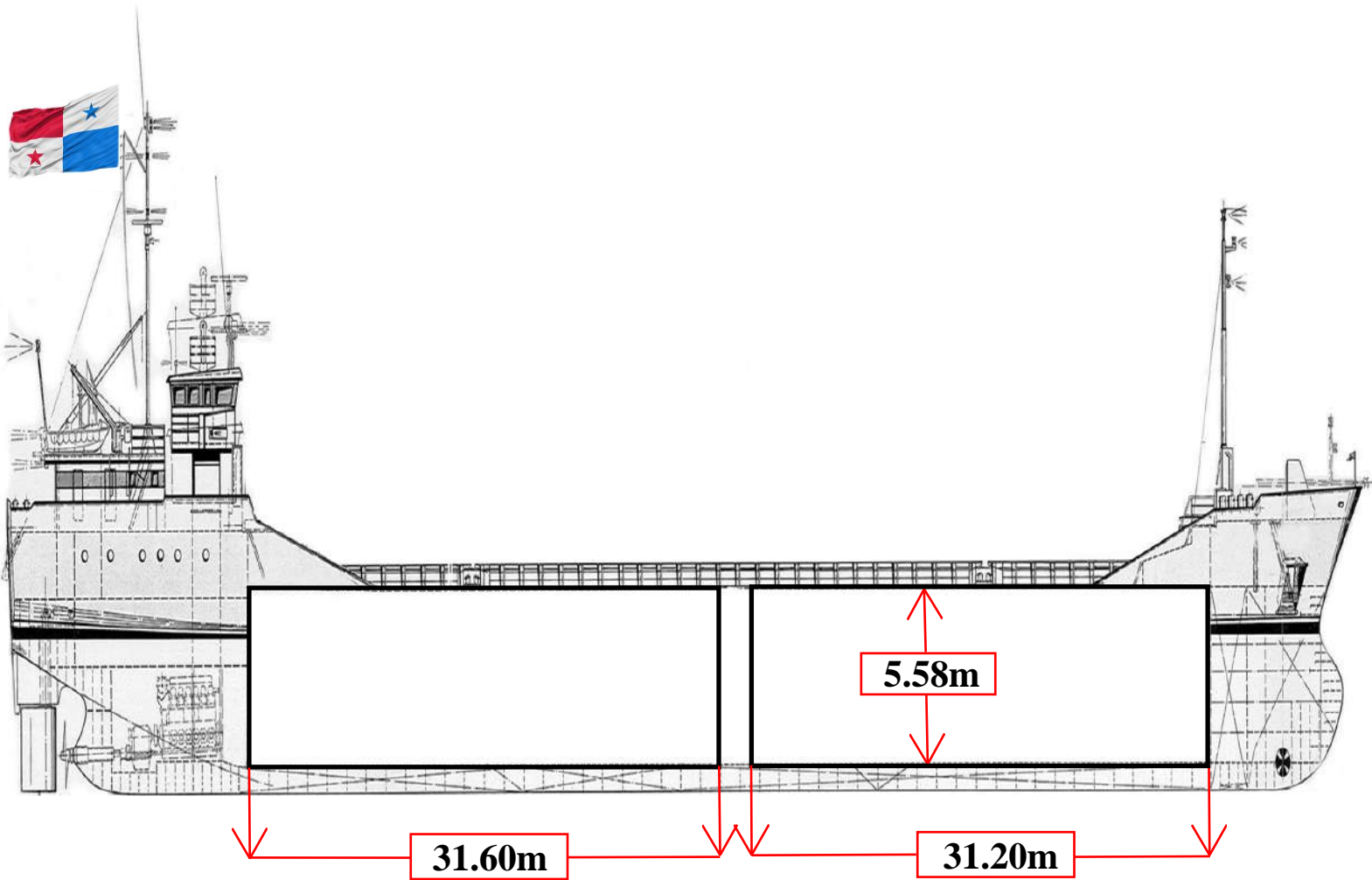



# Hold Photos

